

Version 版次	Change Description 变更描述	Date 日期	Approved by 审核
A	初版发行	08/09-'22	Yi Xiao Xu

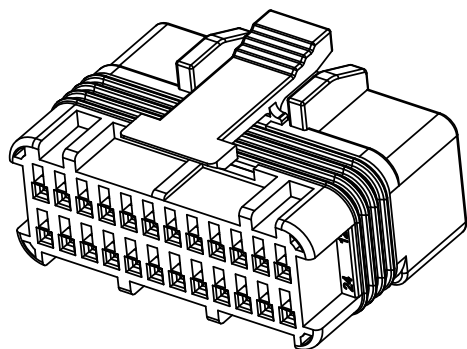
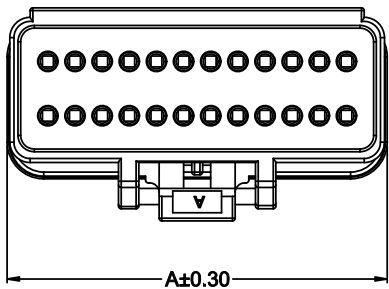

3D View

NOTES

*Material

Housing:PPE UL94V-0;
 Seal ring:Silicon rubber;
 Seal plug:Silicon rubber;

*Electrical Specification

Dielectric Withstanding Voltage:1000 VAC One Minute.
 Current Rating: 3 Ampere Max.
 Voltage Rating: 100V AC/DC Max.
 Insulation Resistance: 1000 MΩ min.
 Operating Temperature: -40℃ To +105℃.
 Waterproof Grade:IP67
 Mate With:M20036S-2xN-C

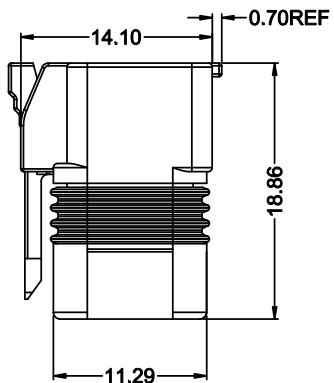
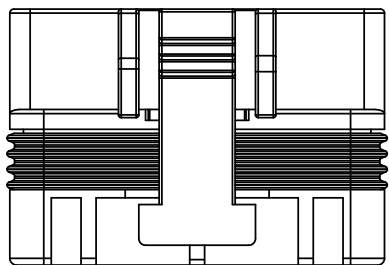

Part No. :M20032S-2xN-C

Color:N:Nature/B:Black/G:Gray
 Pin No.:Pin No.:2x2~2x12PIN

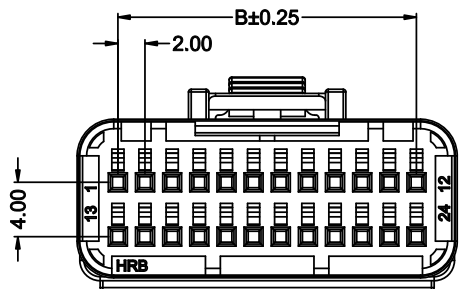

Circuit No.	A	B	Circuit No.	A	B
2x2	8.0	2.0	2x9	22.0	16.0
2x3	10.0	4.0	2x10	24.0	18.0
2x4	12.0	6.0	2x12	28.0	22.0
2x5	14.0	8.0			
2x6	16.0	10.0			
2x7	18.0	12.0			
2x8	20.0	14.0			

料号 (Part No.)	M20032S-2xN-C		
产品名称 (Product Name)	Water Proof 2.0 Pitch Male 2xN Pin		
比例(Scale)	1:1	版本(Version)	A

UNIT:mm	
Tolerance:	Angular Dim.
.XXX ±0.10	.XX° ±1°
.XX ±0.20	.X° ±2°
.X ±0.30	X.° ±3°



东莞市鸿儒连接器有限公司
 Hong Ru Connectors(DG) Co.,Ltd.

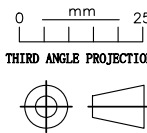

核准Approved:	日期Date:	08/09-'22
审核Checked:	日期Date:	08/09-'22
设计Designed:	Yi Xiao Xu	日期Date: 08/09-'22

Version 版次	Change Description 变更描述	Date 日期	Approved by 签核
A	初版发行	08/09-'22	Yi Xiao Xu

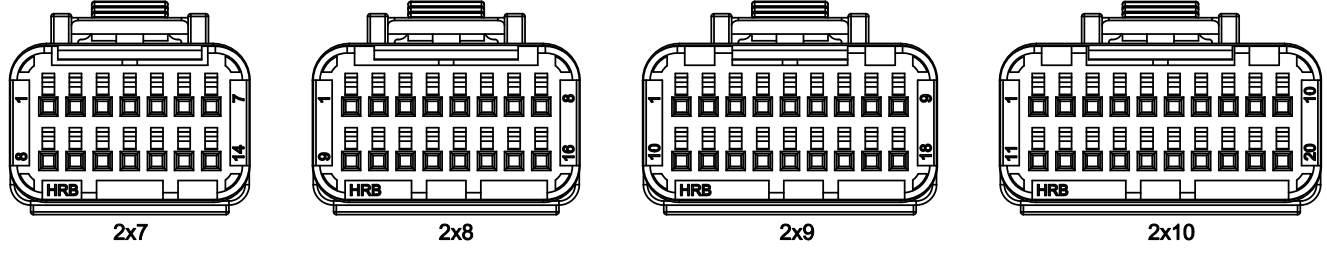
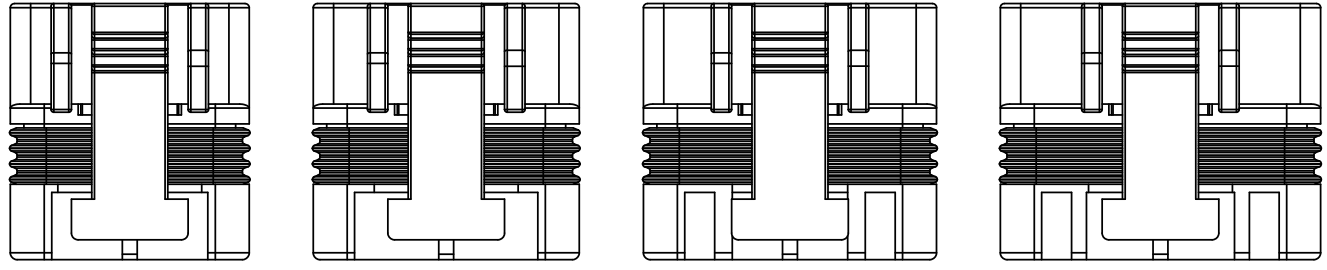
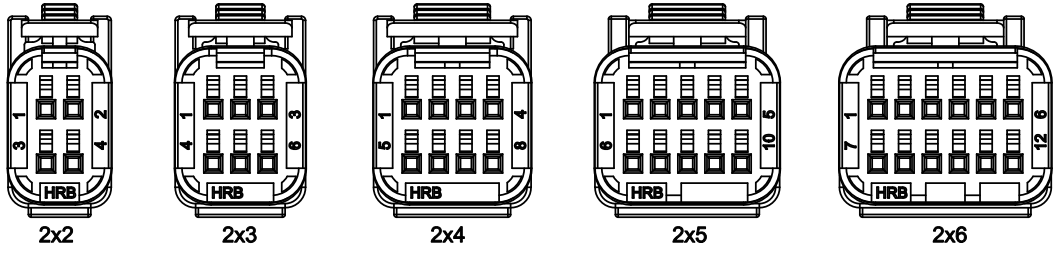
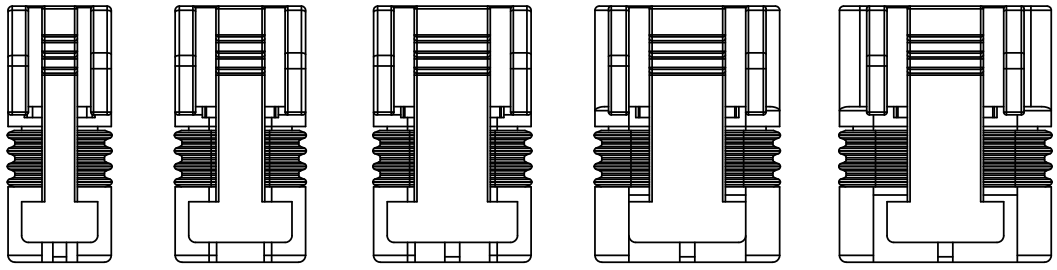

料号 (Part No.)	M20032S-2xN-C		
产品名称 (Product Name)	Water Proof 2.0 Pitch Male 2xN Pin		
比例(Scale)	1:1	版本(Version)	A

UNIT:mm	
Tolerance:	Angular Dim.
.XXX ±0.10	.XX° ±1°
.XX ±0.20	.X° ±2°
.X ±0.30	X.° ±3°

HRB
HRBCN

东莞市鸿儒连接器有限公司

Hong Ru Connectors(DG) Co.,Ltd.

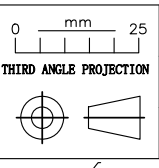

核准 Approved:		日期 Date:	08/09-'22
审核 Checked:		日期 Date:	08/09-'22
设计 Designed:	Yi Xiao Xu	日期 Date:	08/09-'22

A
B
C
D
E
F

A
B
C
D
E
F